

Aanzicht:

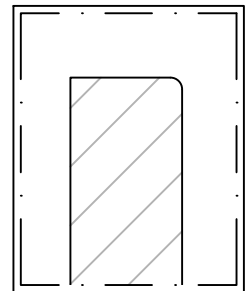

Snede:

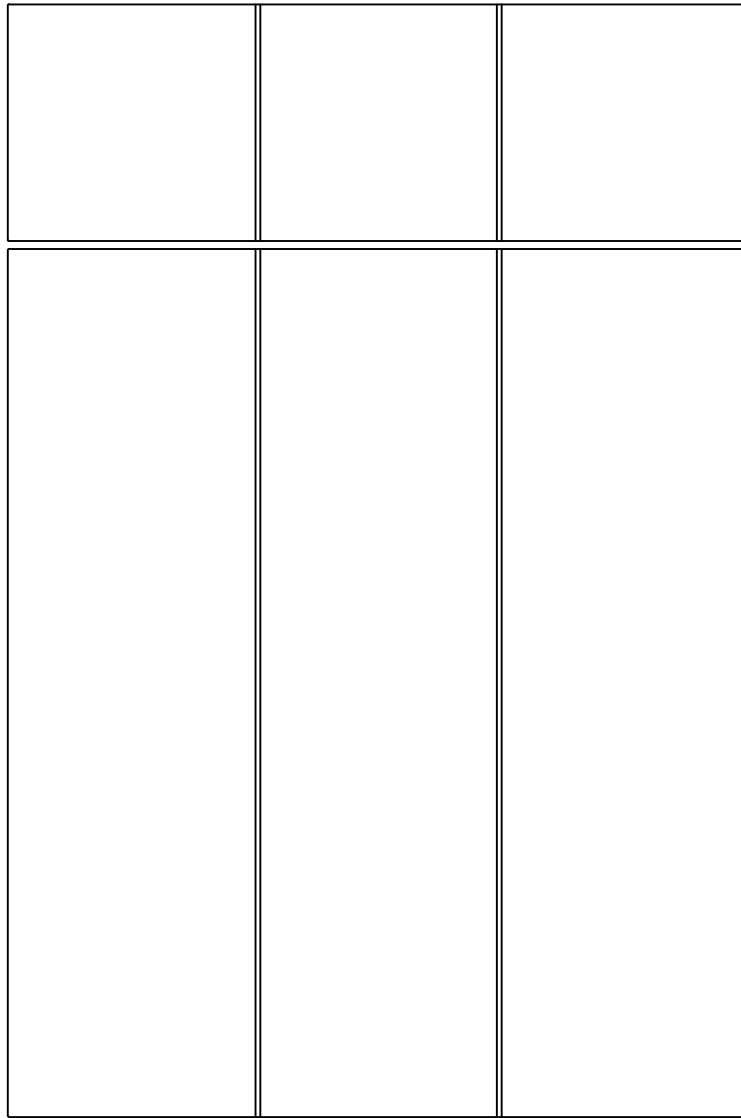
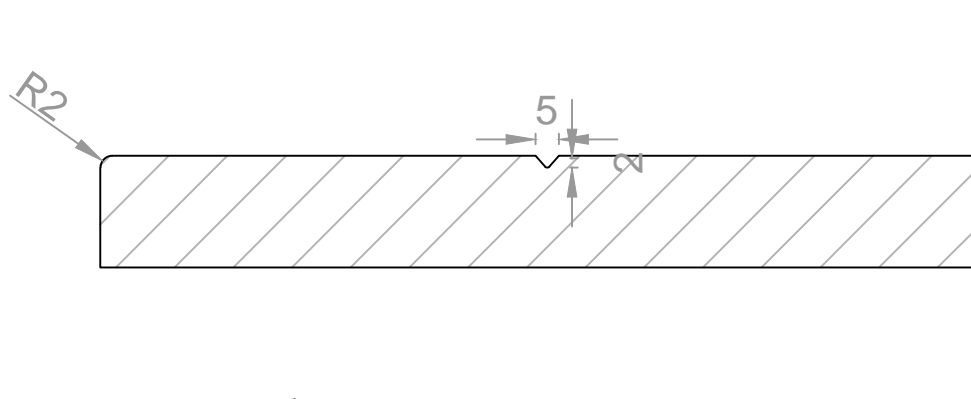

!Steeds het aantal groeven vermelden, standaard afstand op 100mm!

Model: M5002

18mm

Model: M6002

22mm

RD DESIGN

Tel: 0032 (0) 11 94 60 37

Fax: 0032 (0) 11 91 15 89

info@rd-design.be

Versie: 15.01

Eenheid: mm

Proj.: 

Datum: 01/10/2014

rd design